

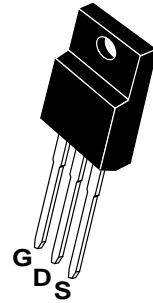

Features:

- Low Intrinsic Capacitances.
- Excellent Switching Characteristics.
- Extended Safe Operating Area.
- Unrivalled Gate Charge :Qg=30nC (Typ.).
- BVDSS=900V,Id=6A
- R_{DS(on)} : 2.1Ω (Max) @V_G=10V
- 100% Avalanche Tested



Schematic diagram

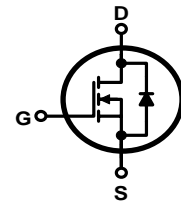

Marking Diagram



- Y = Year
- A = Assembly Location
- WW = Work Week
- FIR6N90F = Specific Device Code

Absolute Maximum Ratings (Ta=25°C unless otherwise noted)

Symbol	Parameter	Value	Unit
V _{DSS}	Drain-Source Voltage	900	V
I _D	Drain Current	T _j =25°C	6.0
		T _j =100°C	3.9
V _{GS(TH)}	Gate Threshold Voltage	±30	V
E _{AS}	Single Pulse Avalanche Energy (note1)	300	mJ
I _{AR}	Avalanche Current (note2)	6.0	A
P _D	Power Dissipation (T _j =25°C)	56	W
T _j	Junction Temperature(Max)	150	°C
T _{stg}	Storage Temperature	-55~+150	°C
TL	Maximum lead temperature for soldering purpose,1/8" from case for 5 seconds	300	°C

Thermal Characteristics

Symbol	Parameter	Typ.	Max.	Unit
R _{θJC}	Thermal Resistance,Junction to Case	-	2.23	°C/W
R _{θJA}	Thermal Resistance,Junction to Ambient	-	120	°C/W

**Electrical Characteristics** (Ta=25°C unless otherwise noted)

Symbol	Parameter	Test Condition	Min.	Typ.	Max.	Unit
Off Characteristics						
BV_{DSS}	Drain-Source Breakdown Voltage	$I_D=250\mu A, V_{GS}=0$	900	-	-	V
$\Delta BV_{DSS}/\Delta T_J$	Breakdown Voltage Temperature Coefficient	$I_D=250\mu A$, Reference to 25°C	-	1.07	-	V/°C
I_{DSS}	Zero Gate Voltage Drain Current	$V_{DS}=900V, V_{GS}=0V$	-	-	10	μA
		$V_{DS}=720V, T_J=125^\circ C$	-	-	100	
I_{GSSF}	Gate-body leakage Current, Forward	$V_{GS}=+30V, V_{DS}=0V$	-	-	100	nA
I_{GSSR}	Gate-body leakage Current, Reverse	$V_{GS}=-30V, V_{DS}=0V$	-	-	-100	
On Characteristics						
$V_{GS(TH)}$	Date Threshold Voltage	$I_D=250\mu A, V_{DS}=V_{GS}$	3	-	5	V
$R_{DS(ON)}$	Static Drain-Source On-Resistance	$I_D=3A, V_{GS}=10V$	-	-	2.1	Ω
Dynamic Characteristics						
C_{iss}	Input Capacitance	$V_{DS}=25V, V_{GS}=0, f=1.0MHz$	-	1680	-	μF
C_{oss}	Output Capacitance		-	110	-	
C_{rss}	Reverse Transfer Capacitance		-	11	-	
Switching Characteristics						
$T_d(on)$	Turn-On Delay Time	$V_{DD}=450V, I_D=6A, R_G=25\Omega$ (Note 3,4)	-	35	80	ns
T_r	Turn-On Rise Time		-	90	190	
$T_d(off)$	Turn-Off Delay Time		-	55	120	
T_f	Turn-Off Rise Time		-	60	130	
Q_g	Total Gate Charge	$V_{DS}=720V, V_{GS}=10V, I_D=6A$ (Note 3,4)	-	30	40	nC
Q_{gs}	Gate-Source Charge		-	9.0	-	
Q_{gd}	Gate-Drain Charge		-	12	-	
Drain-Source Diode Characteristics and Maximum Ratings						
I_S	Max. Diode Forward Current	-	-	-	6	A
I_{SM}	Max. Pulsed Forward Current	-	-	-	24	
V_{SD}	Diode Forward Voltage	$I_D=6A$	-	-	1.4	V
T_{rr}	Reverse Recovery Time	$I_S=6A, V_{GS}=0V, diF/dt=100A/\mu s$	-	630	-	nS
Q_{rr}	Reverse Recovery Charge	(Note3)	-	6.9	-	μC

- Notes : 1, L=16.7mH, IAS=6A, VDD=50V, RG=25Ω, Starting T_J=25°C
 2, Repetitive Rating : Pulse width limited by maximum junction temperature
 3, Pulse Test : Pulse Width ≤ 300μs, Duty Cycle ≤ 2%
 4, Essentially Independent of Operating Temperature



Typical Characteristics

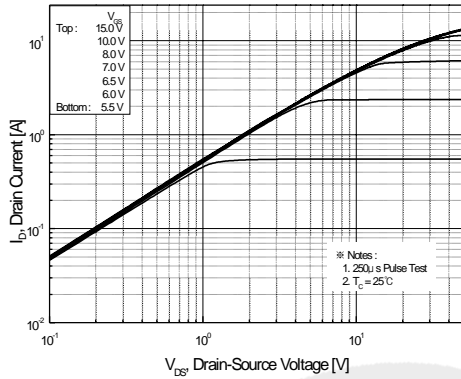

Figure 1. On-Region Characteristics

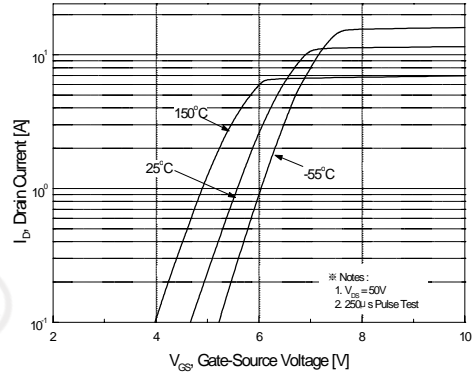

Figure 2. Transfer Characteristics

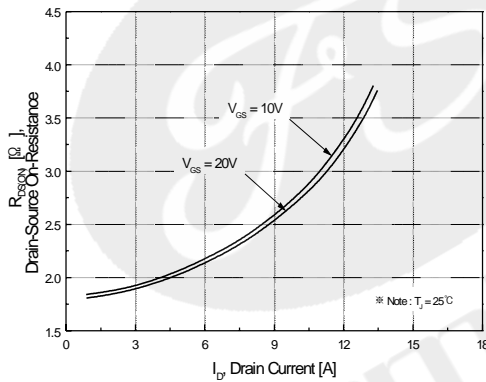

Figure 3. On-Resistance Variation vs Drain Current and Gate Voltage

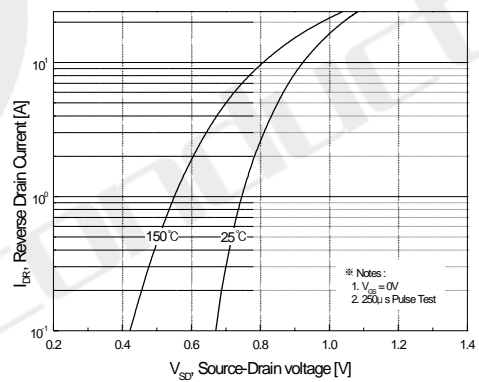

Figure 4. Body Diode Forward Voltage Variation with Source Current and Temperature

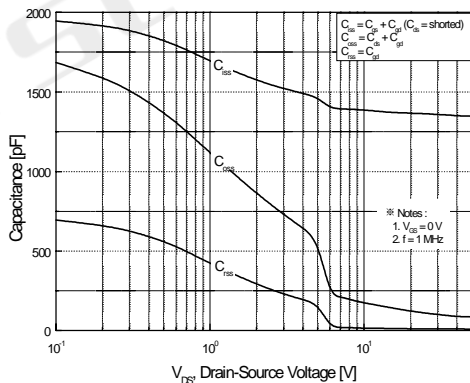

Figure 5. Capacitance Characteristics

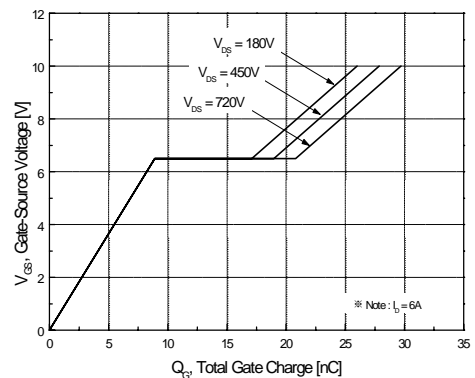

Figure 6. Gate Charge Characteristics

Typical Characteristics (Continued)

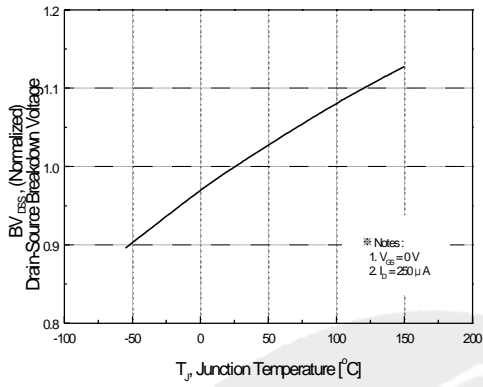

Figure 7. Breakdown Voltage Variation vs Temperature

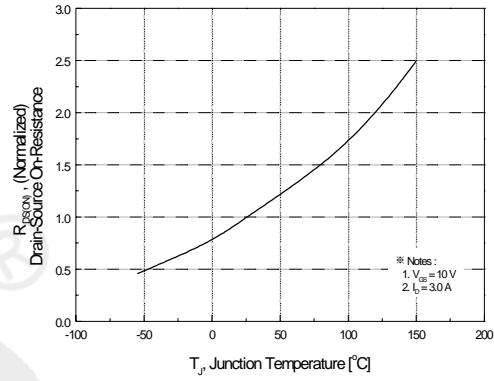

Figure 8. On-Resistance Variation vs Temperature

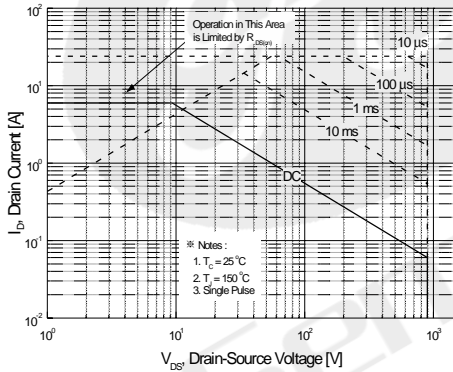

Figure 9-2. Maximum Safe Operating Area

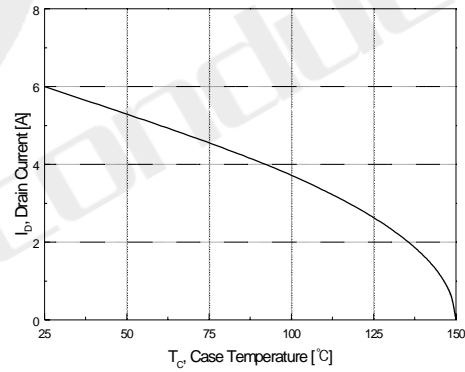

Figure 10. Maximum Drain Current vs Case Temperature

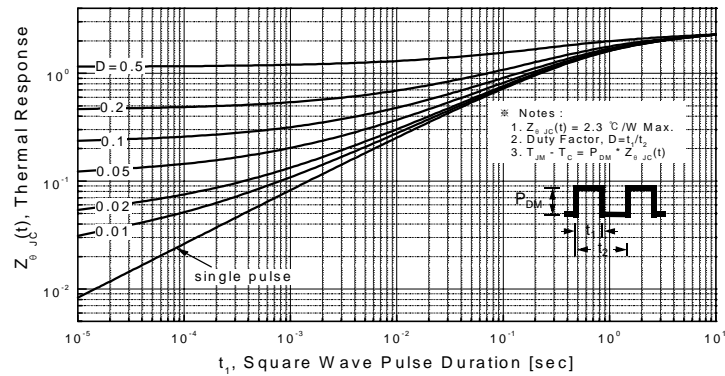
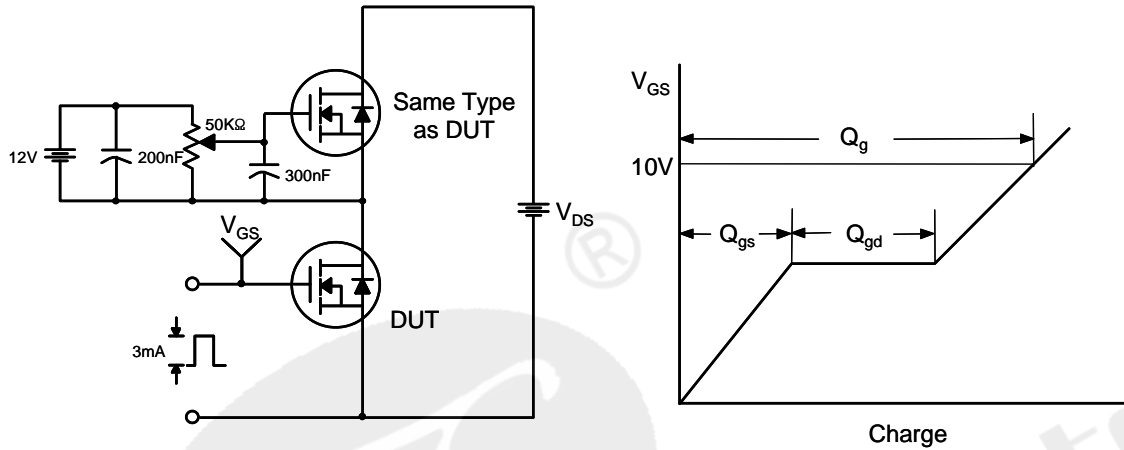
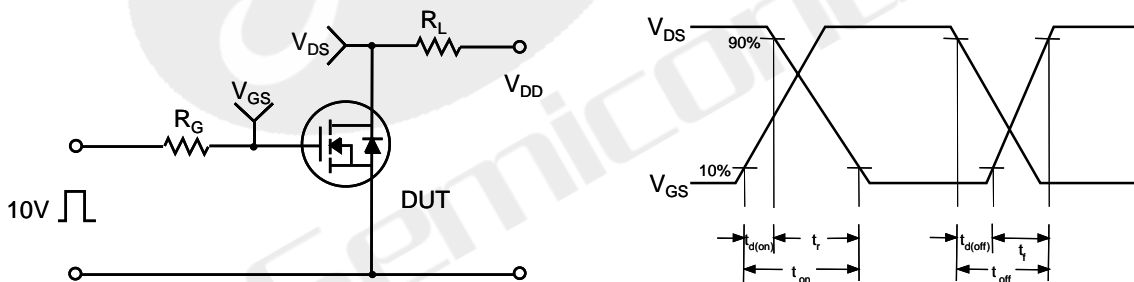

Figure 11-2. Transient Thermal Response Curve

Gate Charge Test Circuit & Waveform



Resistive Switching Test Circuit & Waveforms



Unclamped Inductive Switching Test Circuit & Waveforms

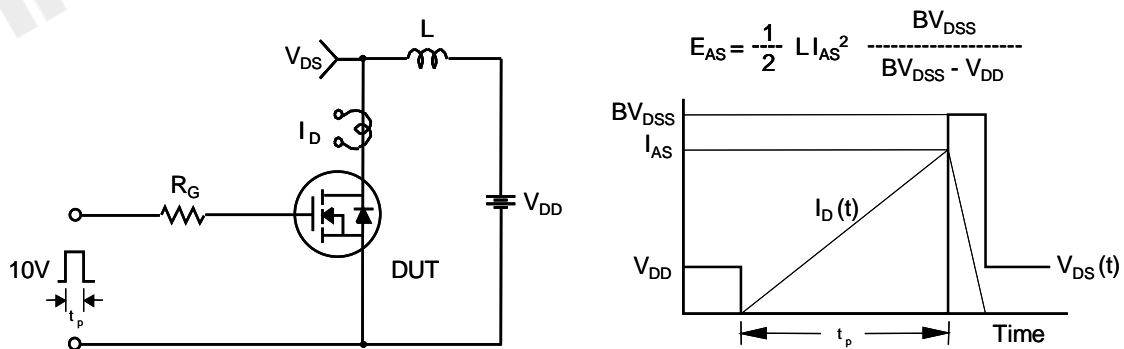

Peak Diode Recovery dv/dt Test Circuit & Waveform

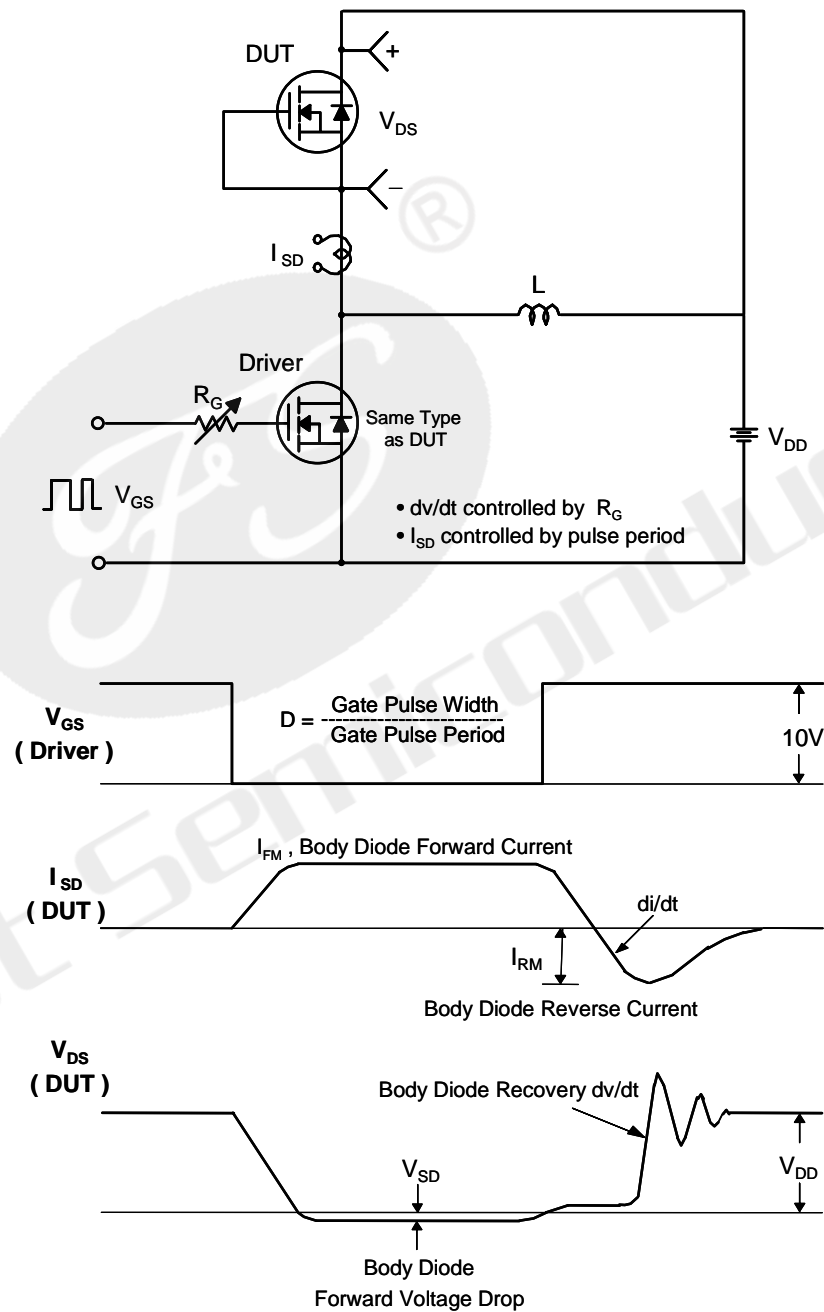



Package Dimension

TO-220F

Unit: mm

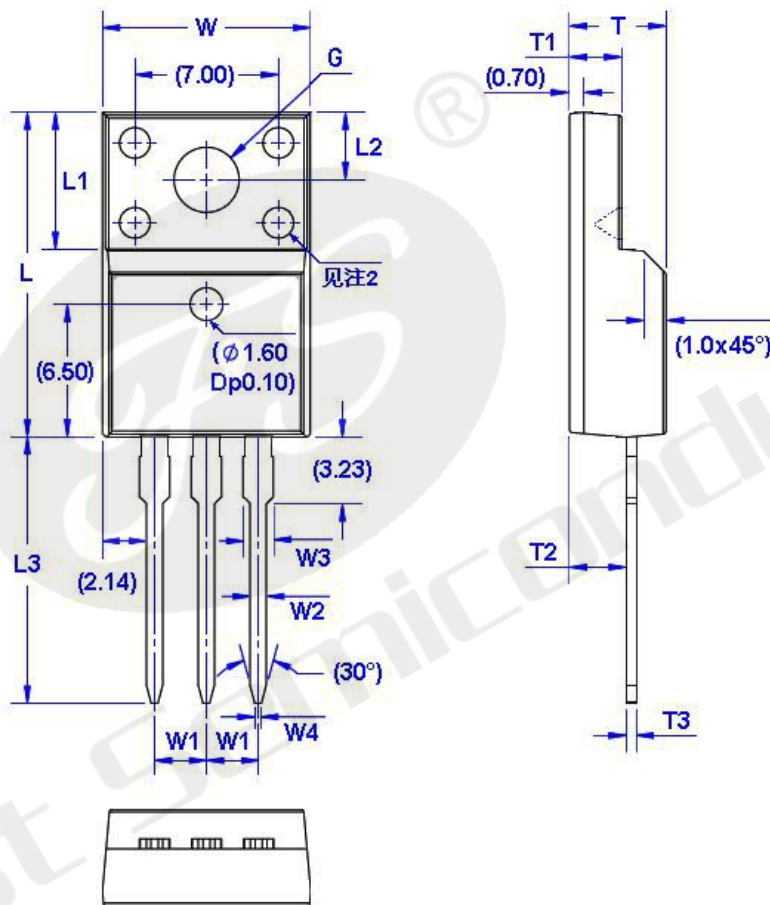

Symbol	Size		Symbol	Size		Symbol	Size		Symbol	Size	
	Min	Max		Min	Max		Min	Max		Min	Max
W	9.96	10.36	W4	0.25	0.45	L3	12.78	13.18	T3	0.45	0.60
W1	2.54 (TYP)		L	15.67	16.07	T	4.50	4.90	G(Φ)	3.08	3.28
W2	0.70	0.90	L1	6.48	6.88	T1	2.34	2.74			
W3	1.24	1.47	L2	3.20	3.40	T2	2.56	2.96			



Declaration

- FIRST reserves the right to change the specifications, the same specifications of products due to different packaging line mold, the size of the appearance will be slightly different, shipped in kind, without notice! Customers should obtain the latest version information before ordering, and verify whether the relevant information is complete and up-to-date.
- Any semiconductor product under certain conditions has the possibility of failure or failure, The buyer has the responsibility to comply with safety standards and take safety measures when using FIRST products for system design and manufacturing, To avoid To avoid potential failure risks, which may cause personal injury or property damage!
- Product promotion endless, our company will wholeheartedly provide customers with better products!

ATTACHMENT

Revision History

Date	REV	Description	Page
2018.01.01	1.0	Initial release	